

Order no.: 800091

nivello® crossbar

090/400/73

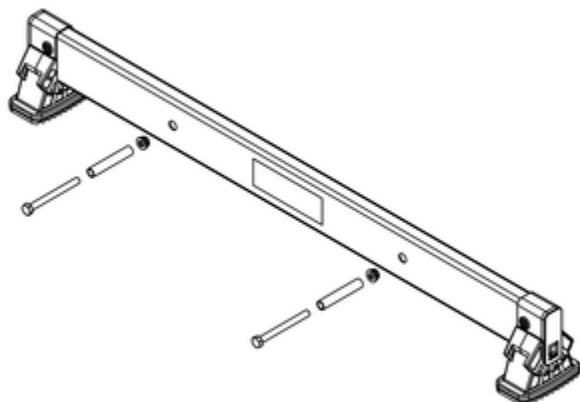

type

093/395/73	120/395/73	093/465/73
120/465/73	093/465/85	120/465/85
120/325/85	120/395/98	093/395/58
093/325/58	093/395/58 GFK	093/395/85
120/395/85	090/400/73	090/417/73
090/373/73	090/432/73	120/445/98
120/325/73	093/325/73	120/465/98

Specification

Transport dimensions (plus packaging) 900 x 104 x 120 mm, 1.2 kg	Business division MUNK Günzburger Steigtechnik	Order no. 800091	Spare part for article no. 011018	Spare part for article no. 011023
Spare part for article no. 011013	Spare part for article no. 012005			

Facts

- High-quality spare part suitable for products from MUNK Günzburger Steigtechnik
- Robust and durable design. Quality. Made in Germany.
- Easy to install, with all the necessary fasteners
- Durable and safe, developed according to the highest quality standards
- If you are unsure about the spare part: Please open the product details page for your base product and select the appropriate spare part from the spare parts list

Description

Our high-quality spare parts are specially developed to ensure the functionality and safety of our products in the long-term. Made from robust materials and manufactured to the highest quality standards, they offer the usual reliability that the MUNK brand stands for. The simple assembly and compatibility with the respective base products makes replacing quick and easy.

To find the right spare part, we recommend opening the product details page for the corresponding base product and using the spare parts list.

Rely on our proven quality: Safety. Made in Germany.

Scope of supply

- Stabiliser (enclosed separately): 1 x
- Installation material: 1 x

Information on sustainability criteria

- Corporate certification: ISO 9001
- Corporate certification: ISO 14001
- Corporate certification: EN 1090
- Corporate certification: EcoVadis
- RoHS
- REACH
- The MUNK Group complies with a Code of Conduct
- The Supply Chain Act does not apply due to our size
- The materials used are listed in the technical specification
- Resource-saving production: own photovoltaic systems
- Energy-efficient consumption during production: LED lighting
- Repairability, durability and quality: 15-year warranty on series products made in Germany
- Recyclability: Our products are mostly made of aluminium, steel or wood and can be fed directly into the recycling process.
- Socially acceptable working conditions in production: fair wages, gender equality
- Economical and recyclable packaging: no use of polystyrene, predominantly use of wood and cardboard, small amounts of plastic
- No health hazards for the users

More product pictures

Corporate certifications

Standards for quality and sustainability



Management System
ISO 9001:2015
ISO 14001:2015
www.tuv.com
ID 9108612548

